

SHF

SHP

SHE



Sele homelifts

 **SELE**

Safe lift, simple life.

ENERGY EFFICIENCY

+ COMFORT

+ SAFETY

AUTOMATIC SLIDING
OR MANUAL SWING DOORS

NEW CABINS
AND MATERIALS

METALLIC STRUCTURE
OR CONCRETE'S SHAFT

NEW BUTTONS





SHF

SHP

SHE



SELE homelifts. Safety, comfort, technology.

The new SELE homelifts allow users to succeed vertical transportation needs through a wide range of solutions both technical and aesthetical. For the best flexibility and value for price SELE propose the new SHP hydraulic homelift, compatible with very small shafts. For the best eco-friendly choice, SELE propose the new SHF and SHE traction homelifts, with very low power consumption and smooth riding thanks to the innovative traction systems: gearless motor for SHE and geared high efficiency patented Gear Silent for SHF.

Sele homelifts are design for:

- ✔ Private houses
- ✔ Commercial and public small buildings
- ✔ Low rise buildings
- ✔ Buildings with walking areas under the lift shaft

Main features of the Sele homelifts.



RIDING COMFORT

Guarantee a pleasant riding experience is one of the Sele priority for all the products. The traction models, SHF and SHE thanks to the innovative motors, guarantee the best level of silence, stopping accuracy and riding smoothness.

The SHP, hydraulic, is also available with the two speeds option.



LOW ENERGY CONSUMPTION

Sele homelifts are all class A-VDI*4707 efficiency.

Powered by the standard single phase 220-240V supply.

Sele homelifts are made to minimize the power consumption during both riding and stand-by.



SAFETY

Follow the standard safety regulations and design the products with "safety first" in mind is a Sele feature.

All the homelifts are equipped with certified safety components.



REDUCED SPACES

The technical solutions engineered by Sele allow to install the homelifts in very reduced spaces.

Reduced pit and headroom for all the three Sele homelifts.

* VDI are guidelines issued by the german engineers association and then do not replace the ISO standards.

Cabins

GAIA



Bianco lucido skinplate walls, ceiling and COP in grigio tempesta skinplate, grey studded rubber floor, two spot lights lighting.

GIOCONDA



Grigio caldo fabric skinplate walls, ceiling and COP in brushed stainless steel, nero rocksolid granit floor, four spot lights lighting.

EVO



Walls and ceiling in brushed stainless steel, Link COP, nero rocksolid floor, starry sky lighting.



Giallo skinplate walls, ceiling and COP in simil spazzolato skinplate, nero linoleum floor, two spot lights lighting.



Bianco microline laminate walls, ceiling and COP in brushed stainless steel, cristallino bianco granit floor, four spot lights lighting.



Bianco lucido skinplate side walls, rosso skinplate rear wall, starry sky lighting, grigio linoleum floor.

Walls

It is possible to customize walls*, door side wall, uprights, ceiling, control panel, landing doors and car door. In case of panoramic solutions, materials used for the interior walls can be applied on request also outside the car.

* Gioconda: available walls up to 1350 mm width for stainless steel and skinplate; a dummy c.o.p. is needed for wider walls

Skinplate

available for

GAIA

GIOCONDA

EVO



Simil inox

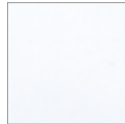

Bianco lucido



Bianco Panna



Sabbia



Giallo



Blu acceso



Blu scuro



Grigio lucido



Rosso



Grigio Tempesta

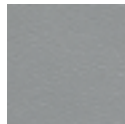

Grigio Alluminio

Special skinplate

available for

GAIA

GIOCONDA

EVO



Beige
fabric style



Grigio caldo
fabric style



Simil Spazzolato

Standard laminates

available for

GIOCONDA

EVO



Special laminates

available for

GIOCONDA

EVO



Stainless Steel

available for

GAIA

GIOCONDA

EVO

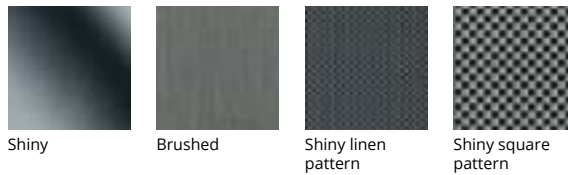

Glass and Mirror

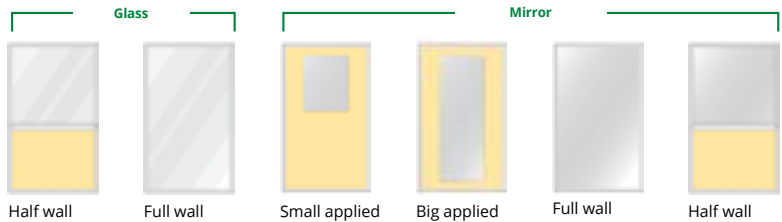

available for

GIOCONDA

GIOCONDA

GAIA

GAIA

GIOCONDA

GIOCONDA

GIOCONDA

EVO

EVO

EVO

Floors

Studded Rubber

available for all cabins



Nero

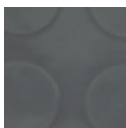

Grigio

Linoleum

available for all cabins

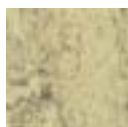

Sabbia



Rosso

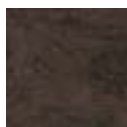

Caffè



Verde



Blu



Grigio

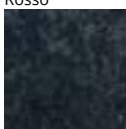

Nero



Viola

Rocksolid granit

available for all cabins



Nero

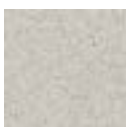

Sabbia



Beige

Cristallino granit

available for all cabins



Nero



Arancione



Blu



Marrone



Petrolio

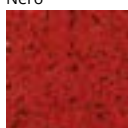

Rosso



Viola

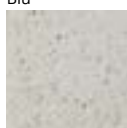

Bianco

Floor By Customer thickness

GAIA Max 7 mm

GIOCONDA Max 14 mm

EVO Max 20 mm

Complements

Ceiling



2 Spotlights



4 Spotlights



Starry

Handrail

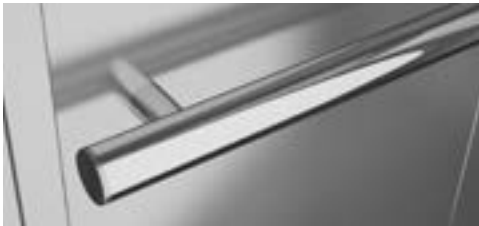

Straight wall handrail full lenght

Brushed or shiny stainless steel.



Curved wall handrail

Brushed stainless steel lenght 501 mm.



Straight handrail over COP

Brushed or shiny stainless steel, lenght 410 mm.

GAIA



Curved handrail over COP

Brushed or shiny stainless steel, lenght 400 mm.

GAIA

Customization

Vertical car operating panel



Standard

GAIA protruding

GIOCONDA protruding

EVO flush

Link

EVO protruding

Landing position indicator



TFT on a Plate



TFT on a Ala

Dot matrix position indicators



TFT position indicator



Theme 1

Theme 2

Theme 3

Theme 4

Theme 5

Pushbuttons



Round pushbutton with red or blue lighting

Dual light round pushbutton

Dual light round pushbutton Australia

Square pushbutton with red or blue lighting

Oval pushbutton with red or blue lighting

Landing operating panels



Plate

Plate with mini dot

Ala with key

Manual swing landing doors

Iron

- ✔ Anti-rust paint color RAL 7032 (standard);
- ✔ RAL paint in a choice of colours;
- ✔ Stainless steel cladding on landing side;
- ✔ Stainless steel cladding on both sides;
- ✔ Wood cladding (landing side or both sides);
- ✔ Fire-rated doors according to EN81-58: EI 120 (C1 only).



C1 door
windowless



V1 door window
100 x 550 mm



P1 door
(the dimension of
the window follows
the door opening)



P2 door
(the dimension of
the window follows
the door opening)

Anodized aluminium with glass panel



Optional door
Glass panel:
- Clear
- Coloured (smoked, grey,
bronze)
Configuration for 4+4+0.76
pane
Door jamb and frame:
- RAL paint finish in a choice of
colours
- Anodised aluminium

Iron jamb and full glass door panel



Optional door
Glass Panel:
- Clear
- Stopsol bronze
- Etched
Jamb:
- RAL paint finish in a choice
of colours
- Stainless steel cladding
brushed finish
- Stainless steel cladding
shiny finish

Folding doors

Car folding doors, manual or automatic (coupled with manual swing landing doors only)

Door opening: 500 ÷ 1100 (mm)
Door height: 1900 ÷ 2100 (mm)



CI DOOR
Windowless



V1 DOOR
Window
100 x 585 mm



P1 DOOR
(the dimension of
the window follows
the door opening)



P1 MAX DOOR
(available only for
automatic model)

Handles

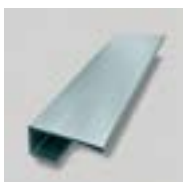

Aluminium anodized - silver
L=8mm)=300 (Optional)



Polymer



Stainless steel aisi 304
Ø=15 L=330 (mm)
(Standard for aluminium doors)
L=550 (mm) (Optional)



Embedded Plastic



Embedded stainless steel
inox aisi 304



External chrome/satin
or brass knob

Automatic side-opening doors



2 panels

with side opening

Door opening (mm): 600 - 650
- 700 - 750 - 800 - 850 - 900

3 panels

with side opening

Door opening (mm): 600 - 650
- 700 - 750 - 800 - 850 - 900 - 950 - 1000 - 1050

Finishings

- Anti-rust paint RAL 7032 (standard)
- RAL paint, colour on request (Only with Sele structure)
- Skinplate and stainless steel (See car finishes)



Glass framed door

Headroom from 2500 mm

Dimensions on request
Clear glass (standard) or colours on request
Door frame finishes:
- Anti-rust paint RAL 7032 (standard) or colour on request
- Stainless steel

Full glass panel

Headroom 2900 mm

Dimensions on request
Clear glass (standard) or colours on request
Door frame and lower guide finishings:
- Anti-rust paint RAL 7032 (standard) or colour on request
- Stainless steel

Glass framed door

Full glass panel

Accessories

CONTROL

Automatic push button (Optional)

The controller stops the car at the selected floor single push.

SAFETY

Emergency lighting (Standard)

Determines the ignition of an emergency light in the car in case of power cut.

Photocell barrier (Optional)

A photocell barrier detects (along the full height) object or people that cross the sill and immediately activates blocking mechanisms.

ARD (Optional)

Enables automatic arrival of the car at floor in the event of a power cut.

Telephone dialler for land line or Gsm (Optional)

In the event of passengers getting trapped, it assures a permanent telephone connection to the emergency number.

ENERGY SAVING

Car light operation (Standard)

The car light is switched off after a set time to permit energy savings; it is automatically switched back on in the event of a call.

Ceiling with led lighting

Results in improved performance in terms of lifespan, efficiency and energy savings.





Cabin and shaft dimensions

The indicated dimensions show the most requested sizes. Customized solutions are also available.

Landing doors can be recessed on the floor up to:

- ✔ 60 mm for automatic 3 panels doors;
- ✔ 90 mm for automatic 2 panels doors;
- ✔ "No door" type in the cabin and swing landing doors:
automatic push button landings/hold to run from the cabin
- ✔ "Folding doors" type in the cabin and single-hinged landing doors:
 - a) manual folding door automatic push button at landings
 - hold to run from the cabin in case of open folding
 - automatic from the cabin in case of closed folding
 - b) automatic folding door
 - automatic push button
- ✔ "Automatic two panels" type: automatic push button
- ✔ "Automatic three panels" type: automatic push button.

Main features SHF

Traction with geared motor homelift

Directive	European Machinery Directive 2006/42/EC
Rated load up to (kg)	500
Max travel (m)	22
Max number of stops	8
Speed m/s	0,15 (0,3*)
Entrances	1, 2, 3
Landing doors	Automatic side opening or manual swing
Cabin doors	Automatic sliding, folding manual/automatic, no door
Door opening (mm)	500 - 1200
Control	Automatic pushbutton at landings, automatic pushbutton or hold to run from the cabin
Power supply	220/240 Volts single phase /50Hz
Machinery	1:1 ratio Gear Silent
Drive system	VVVF
Controller	Embedded in the shaft and in a console on the door frame
Std distance between guide brackets (mm)	1500
Frame	Rucksack
Cabin height (mm)	2080 (<i>Gaia</i>), 2080 (<i>Evo</i>), 2040 (<i>Gioconda</i>)
Pit Depth (mm)	150 (min 130)
Std / Min headroom (mm)	2750/2500 (with cars > 800 x1200)

* not for EU countries. Not 2006/42/EC compliant

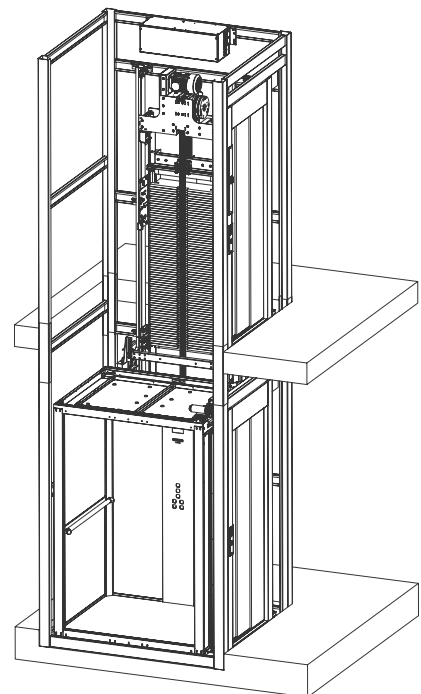

SHF No cabin doors

1 entrance rear frame

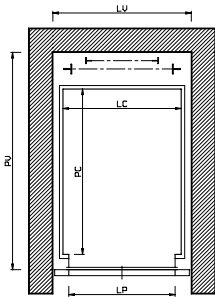

	load (kg)				
	200	270	270	325	500
LC	830	830	900	900	1400
PC	540	1200	1200	1400	1400
LP	750	750	800	800	900
LV	1000	1000	1050	1050	1550
PV	950	1610	1610	1810	1810

1 entrance side frame

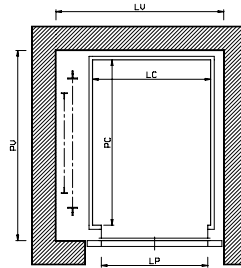

	load (kg)			
	200	250	385	500
LC	550	800	1100	1400
PC	910	1200	1400	1400
LP	500	750	900	900
LV	930	1180	1480	1780
PV	1100	1390	1590	1590

2 opposite entrances

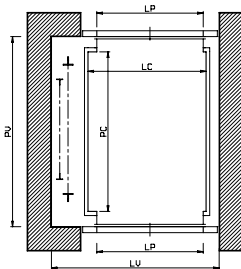

	load (kg)			
	200	250	385	500
LC	550	800	1100	1400
PC	910	1200	1400	1400
LP	500	750	900	900
LV	930	1180	1480	1780
PV	1130	1420	1620	1620

2 adjacent entrances

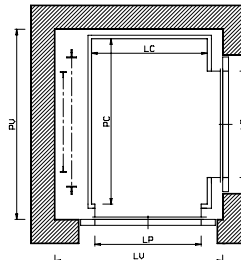

	load (kg)			
	200	360	385	500
LC	580	1200	1100	1400
PC	910	1200	1400	1400
LP	500	800	900	900
LV	990	1610	1510	1810
PV	1100	1390	1590	1590

3 entrances

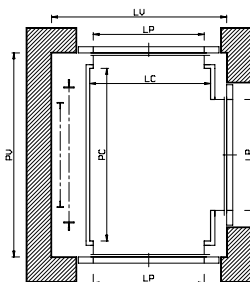

	load (kg)			
	200	360	385	500
LC	580	1200	1100	1400
PC	910	1200	1400	1400
LP	500	800	900	900
LV	990	1610	1510	1810
PV	1130	1420	1620	1620

all dimension in mm

- LC cabin width
- PC cabin depth
- LP door opening
- LV shaft width
- PV shaft depth

SHF Folding doors

1 entrance rear frame

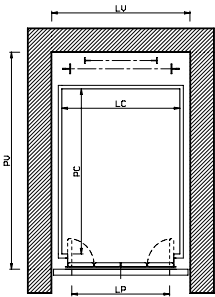

	load (kg)				
	200	270	270	325	500
LC	830	830	900	900	1400
PC	540	1200	1200	1400	1400
LP	750	750	800	800	900
LV	1000	1000	1050	1050	1550
PV	1000	1660	1660	1860	1860

1 entrance side frame

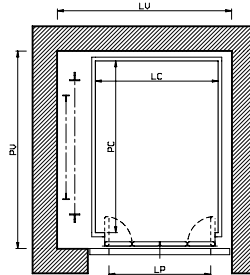

	load (kg)			
	200	270	385	500
LC	580	830	1100	1400
PC	850	1200	1400	1400
LP	500	750	900	900
LV	960	1210	1480	1780
PV	1100	1450	1650	1650

2 opposite entrances

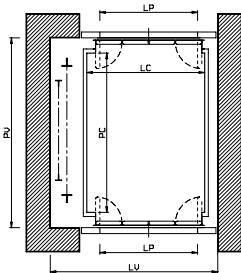

	load (kg)			
	200	270	385	500
LC	580	830	1100	1400
PC	850	1200	1400	1400
LP	500	750	900	900
LV	960	1210	1480	1780
PV	1170	1540	1740	1740

2 adjacent entrances

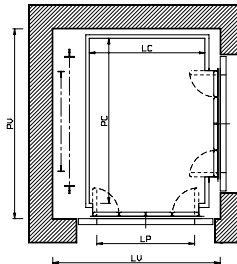

	load (kg)			
	200	360	385	500
LC	620	1200	1100	1400
PC	850	1200	1400	1400
LP	500	800	900	900
LV	1080	1660	1560	1860
PV	1100	1450	1650	1650

3 entrances

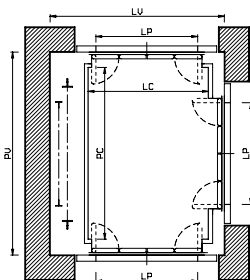

	load (kg)			
	200	360	385	500
LC	620	1200	1100	1400
PC	850	1200	1400	1400
LP	500	800	900	900
LV	1080	1660	1560	1860
PV	1170	1540	1610	1810

all dimension in mm

- LC cabin width
- PC cabin depth
- LP door opening
- LV shaft width
- PV shaft depth

SHF Automatic doors 2 panels

1 entrance rear frame

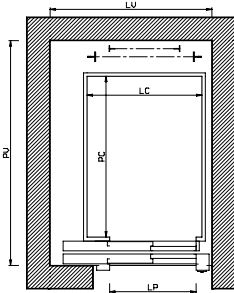

	load (kg)				
	200	270	385	325	500
LC	1050	900	1200	900	1400
PC	540	1200	1200	1400	1400
LP	700	750	800	750	900
LV	1250	1300	1400	1300	1550
PV	1100	1760	1760	1960	1960

1 entrance side frame

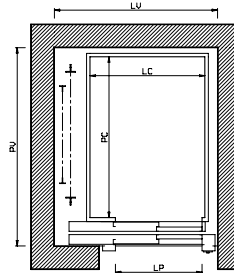

	load (kg)			
	225	270	385	500
LC	870	900	1100	1400
PC	920	1200	1400	1400
LP	700	750	900	900
LV	1250	1300	1550	1780
PV	1250	1550	1750	1750

2 opposite entrances

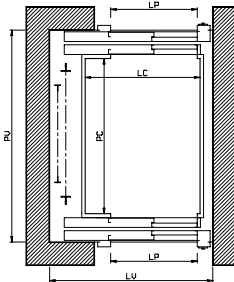

	load (kg)			
	225	270	385	500
LC	870	900	1100	1400
PC	930	1200	1400	1400
LP	700	750	900	900
LV	1250	1300	1550	1780
PV	1450	1720	1920	1920

2 adjacent entrances

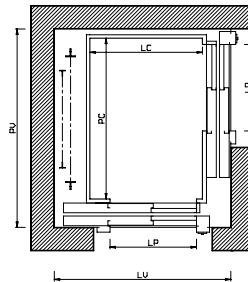

	load (kg)			
	300	360	385	500
LC	870	1200	1100	1400
PC	1000	1200	1400	1400
LP	700	800	900	900
LV	1430	1760	1750	1960
PV	1350	1550	1750	1750

3 entrances

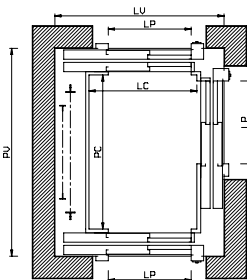

	load (kg)			
	300	360	385	500
LC	870	1200	1100	1400
PC	1000	1200	1400	1400
LP	700	800	900	900
LV	1430	1760	1750	1960
PV	1520	1720	1620	1620

all dimension in mm

- LC cabin width
- PC cabin depth
- LP door opening
- LV shaft width
- PV shaft depth

SHF Automatic doors 3 panels

1 entrance rear frame

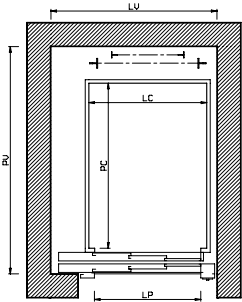

	load (kg)				
	200	270	330	325	500
LC	840	900	1100	900	1400
PC	540	1200	1200	1400	1400
LP	600	750	800	750	900
LV	1000	1200	1280	1200	1550
PV	1040	1700	1700	1900	1900

1 entrance side frame

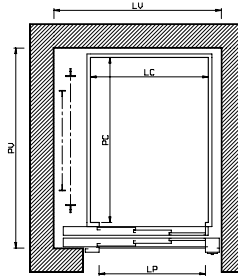

	load (kg)			
	225	270	385	500
LC	650	800	1100	1400
PC	930	1200	1400	1400
LP	600	750	900	900
LV	1030	1200	1480	1780
PV	1200	1480	1680	1680

2 opposite entrances

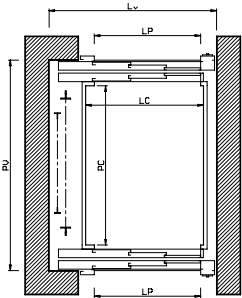

	load (kg)			
	225	270	385	500
LC	650	800	1100	1400
PC	950	1200	1400	1400
LP	600	750	900	900
LV	1030	1200	1480	1780
PV	1350	1600	1800	1800

2 adjacent entrances

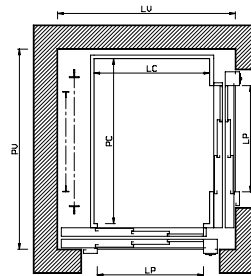

	load (kg)			
	200	360	385	500
LC	660	1200	1100	1400
PC	820	1200	1400	1400
LP	600	800	900	900
LV	1160	1700	1600	1900
PV	1200	1480	1680	1680

3 entrances

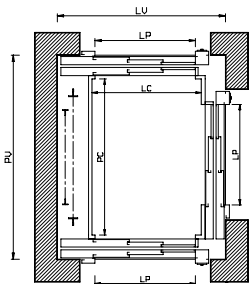

	load (kg)			
	200	360	385	500
LC	660	1200	1100	1400
PC	820	1200	1400	1400
LP	600	800	900	900
LV	1160	1700	1600	1900
PV	1350	1600	1800	1800

all dimension in mm

- LC cabin width
- PC cabin depth
- LP door opening
- LV shaft width
- PV shaft depth

Main features SHP

Hydraulic homelift

Directive	European Machinery Directive 2006/42/EC
Rated load up to (kg)	400 (500*)
Max travel (m)	13,4 (16,9*)
Max number of stops	8
Speed m/s	0,15 (0,25**)
Entrances	1, 2, 3
Landing doors	Automatic side opening or manual swing
Cabin doors	Automatic sliding, folding manual/automatic, no door
Door opening (mm)	500 - 1200
Control	Automatic pushbutton at landings, automatic pushbutton or hold to run from the cabin
Power supply	220 Volts single phase /50Hz
Machinery	Indirect acting piston
Drive system	1 or 2 speeds
Controller	In a cabinet
Std distance between guide brackets (mm)	1500
Frame	Rucksack
Cabin height (mm)	2080 (Gaia), 2080 (Evo), 2040 (Gioconda)
Pit Depth (mm)	150 (min 130)
Std / Min headroom (mm)	2300 without cabin door(or with manual folding door), 2400 with automatic sliding doors

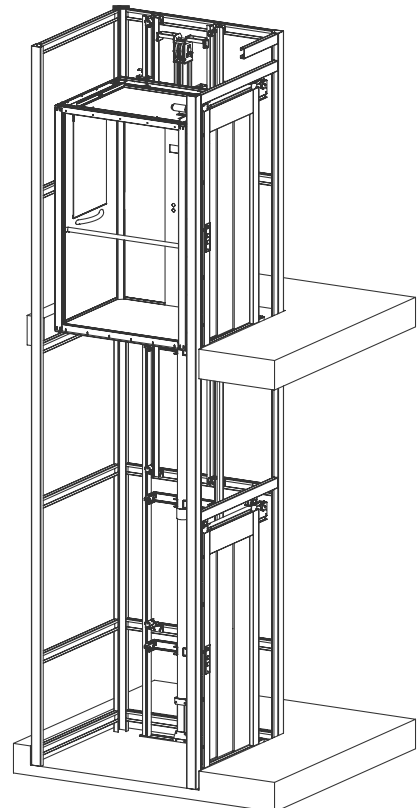

* with limitations

** not for EU countries. Not 2006/42/EC compliant

TECHNICAL SPECS

SHP No cabin doors

1 entrance rear frame

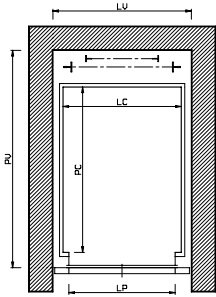

	load (kg)		
	150	270	270
LC	550	830	900
PC	540	1200	1200
LP	500	750	800
LV	710	990	1050
PV	950	1580	1580

1 entrance side frame

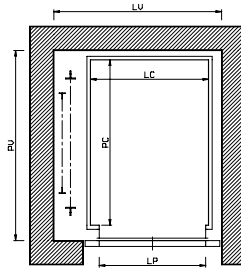

	load (kg)		
	150	250	385
LC	550	800	1100
PC	580	1200	1400
LP	500	750	900
LV	900	1150	1450
PV	770	1390	1590

2 opposite entrances

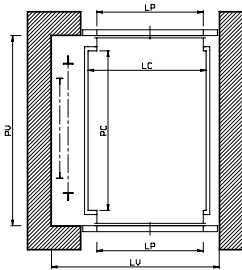

	load (kg)		
	150	250	385
LC	550	800	1100
PC	580	1200	1400
LP	500	750	900
LV	900	1150	1450
PV	800	1420	1620

2 adjacent entrances

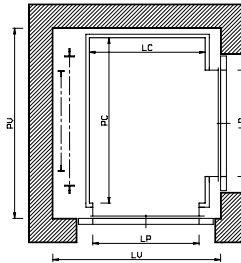

	load (kg)		
	150	2360	385
LC	580	1200	1100
PC	600	1200	1400
LP	500	800	900
LV	970	1590	1490
PV	790	1390	1590

3 entrances

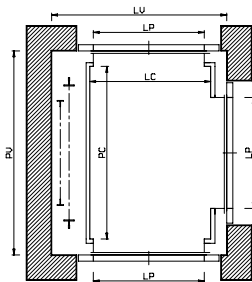

	load (kg)		
	200	360	385
LC	580	1200	1100
PC	600	1200	1400
LP	500	800	900
LV	970	1590	1490
PV	820	1420	1620

all dimension in mm

- LC cabin width
- PC cabin depth
- LP door opening
- LV shaft width
- PV shaft depth

SHP Folding doors

1 entrance rear frame

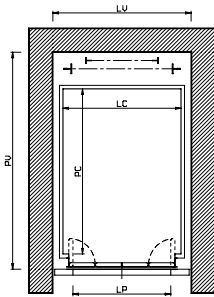

	load (kg)		
	150	270	270
LC	580	830	900
PC	540	1200	1200
LP	500	750	800
LV	740	990	1050
PV	980	1640	1640

1 entrance side frame

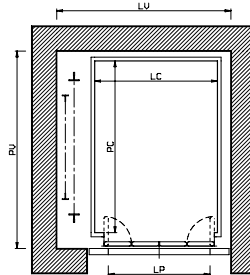

	load (kg)		
	150	270	385
LC	580	830	1100
PC	580	1200	1400
LP	500	750	900
LV	930	1180	1450
PV	830	1450	1650

2 opposite entrances

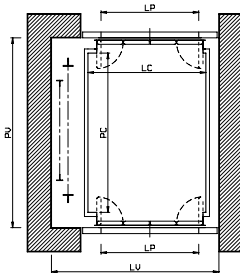

	load (kg)		
	150	270	385
LC	580	830	1100
PC	580	1200	1400
LP	500	750	900
LV	930	1180	1450
PV	920	1540	1740

2 adjacent entrances

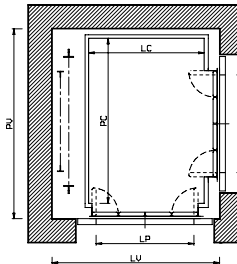

	load (kg)		
	150	360	385
LC	620	1200	1100
PC	620	1200	1400
LP	500	800	900
LV	1060	1640	1540
PV	870	1450	1650

3 entrances

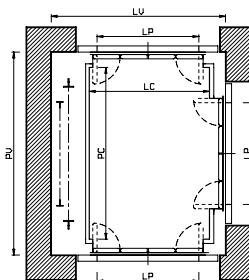

	load (kg)		
	150	2360	385
LC	620	1200	1100
PC	620	1200	1400
LP	500	800	900
LV	1060	1640	1540
PV	960	1540	1740

all dimension in mm

- LC cabin width
- PC cabin depth
- LP door opening
- LV shaft width
- PV shaft depth

TECHNICAL SPECS

SHP Automatic doors 2 panels

1 entrance rear frame

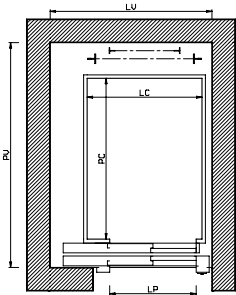

	load (kg)		
	150	270	385
LC	1050	900	1200
PC	540	1200	1200
LP	700	750	800
LV	1250	1300	1400
PV	1080	1740	1740

1 entrance side frame

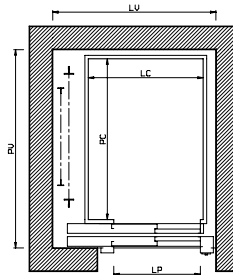

	load (kg)		
	150	270	385
LC	900	900	1100
PC	580	1200	1400
LP	700	750	900
LV	1250	1300	1550
PV	920	1550	1750

2 opposite entrances

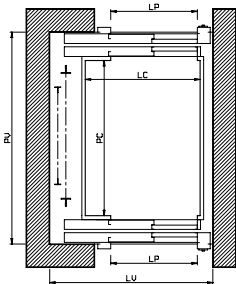

	load (kg)		
	150	270	385
LC	900	900	1100
PC	600	1200	1400
LP	700	750	900
LV	1250	1300	1550
PV	1120	1720	1920

2 adjacent entrances

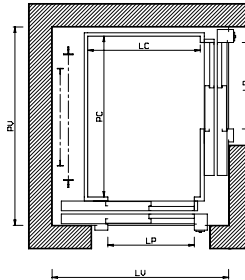

	load (kg)		
	225	360	385
LC	900	1200	1100
PC	1000	1200	1400
LP	700	800	900
LV	1430	1730	1750
PV	1350	1550	1750

3 entrances

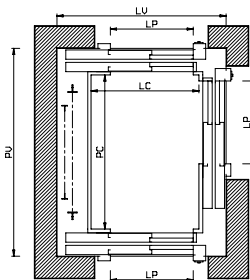

	load (kg)		
	300	360	385
LC	900	1200	1100
PC	1020	1200	1400
LP	700	800	900
LV	1430	1730	1750
PV	1540	1720	1920

all dimension in mm

LC cabin width
 PC cabin depth
 LP door opening
 LV shaft width
 PV shaft depth

SHP Automatic doors 3 panels

1 entrance rear frame

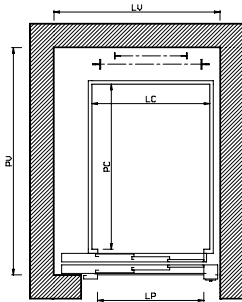

	load (kg)		
	150	270	330
LC	840	900	1100
PC	540	1200	1200
LP	600	750	800
LV	1000	1200	1280
PV	1010	1670	1670

1 entrance side frame

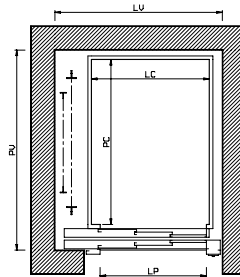

	load (kg)		
	150	270	385
LC	650	850	1100
PC	580	1200	1400
LP	600	750	900
LV	1000	1200	1450
PV	850	1480	1680

2 opposite entrances

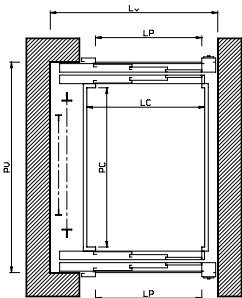

	load (kg)		
	150	270	385
LC	650	850	1100
PC	600	1200	1400
LP	600	750	900
LV	1000	1200	1450
PV	1000	1600	1800

2 adjacent entrances

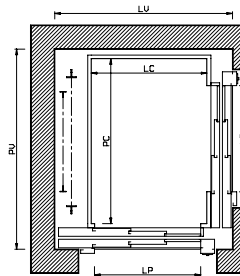

	load (kg)		
	150	360	385
LC	660	1200	1100
PC	820	1200	1400
LP	600	800	900
LV	1130	1670	1570
PV	1100	1480	1680

3 entrances

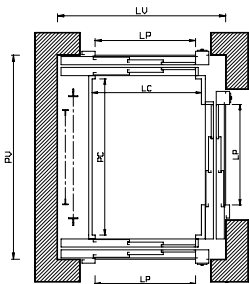

	load (kg)		
	200	360	385
LC	660	1200	1100
PC	1070	1200	1400
LP	600	800	900
LV	1130	1670	1570
PV	1470	1600	1800

all dimension in mm

- LC cabin width
- PC cabin depth
- LP door opening
- LV shaft width
- PV shaft depth

Main features SHE

Traction with gearless motor homelift

Speed m/s	European Machinery Directive 2006/42/EC
Rated load up to (kg)	400
Max travel (m)	22
Max number of stops	8
Speed m/s	0,15 (0,3*)
Entrances	1, 2, 3
Landing doors	Automatic side opening or manual swing
Cabin doors	Automatic sliding, folding manual/automatic, no door
Door opening (mm)	500 - 1200
Control	Automatic pushbutton at landings, automatic pushbutton or hold to run from the cabin
Power supply	220 Volts single phase /50Hz
Machinery	2:1 ratio <i>Gearless</i>
Drive system	VVVF
Controller	Embedded in the shaft and in a console on the door frame
Std distance between guide brackets (mm)	1500
Frame	Rucksack
Cabin height (mm)	2080 (<i>Gaia</i>), 2080 (<i>Evo</i>), 2040 (<i>Gioconda</i>)
Pit Depth (mm)	150 (min 130)
Std / Min headroom (mm)	2750/2500 (with cars > 800 x1200)

*not for EU countries. Not 2006/42/EC compliant

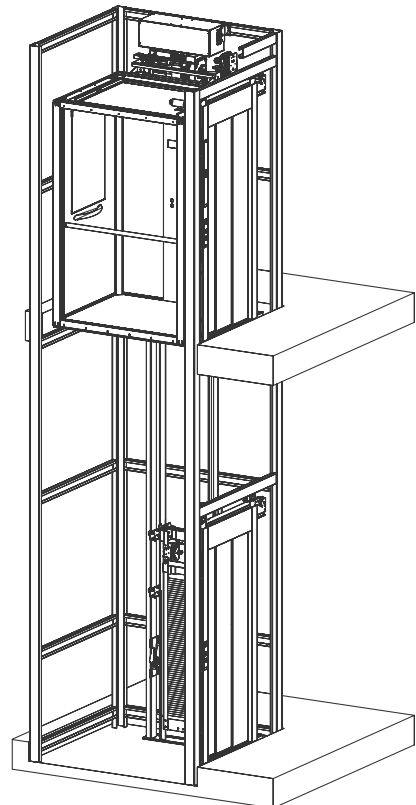

SHE No cabin doors

1 entrance rear frame

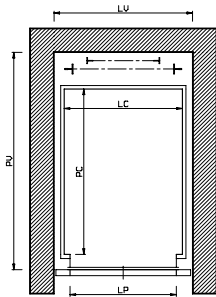

	load (kg)		
	200	270	270
LC	830	830	900
PC	540	1200	1200
LP	750	750	800
LV	1000	1000	1050
PV	950	1610	1610

1 entrance side frame

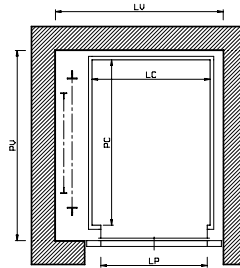

	load (kg)		
	200	250	385
LC	550	800	1100
PC	910	1200	1400
LP	500	750	900
LV	930	1180	1480
PV	1100	1390	1590

2 opposite entrances

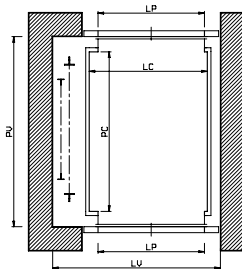

	load (kg)		
	200	250	385
LC	550	800	1100
PC	910	1200	1400
LP	500	750	900
LV	930	1180	1480
PV	1130	1420	1620

2 adjacent entrances

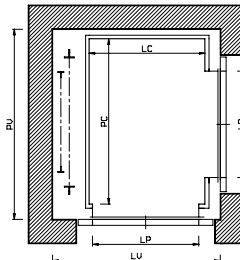

	load (kg)		
	200	360	385
LC	580	1200	1100
PC	910	1200	1400
LP	500	800	900
LV	990	1610	1510
PV	1100	1390	1590

3 entrances

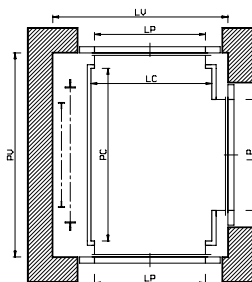

	load (kg)		
	200	360	385
LC	580	1200	1100
PC	930	1200	1400
LP	500	800	900
LV	990	1610	1510
PV	1150	1420	1620

all dimension in mm

- LC cabin width
- PC cabin depth
- LP door opening
- LV shaft width
- PV shaft depth

SHE Folding doors

1 entrance rear frame

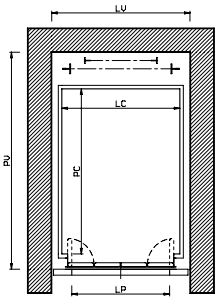

	load (kg)		
	200	270	270
LC	830	830	900
PC	540	1200	1200
LP	750	750	800
LV	1000	1000	1000
PV	1000	1660	1660

1 entrance side frame

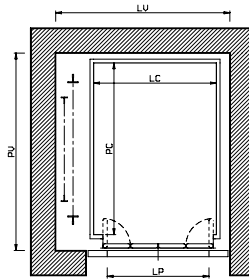

	load (kg)		
	200	270	385
LC	580	830	1100
PC	850	1200	1400
LP	500	750	900
LV	960	1210	1480
PV	1100	1450	1650

2 opposite entrances

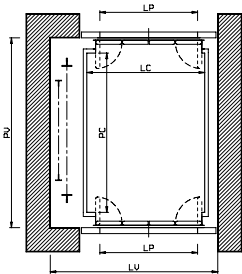

	load (kg)		
	200	270	385
LC	580	830	1100
PC	850	1200	1400
LP	500	750	900
LV	960	1210	1480
PV	1170	1540	1740

2 adjacent entrances

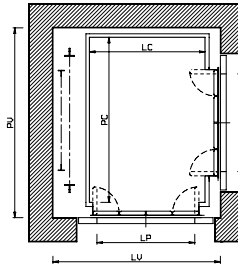

	load (kg)		
	150	360	385
LC	620	1200	1100
PC	620	1200	1400
LP	500	800	900
LV	1080	1640	1560
PV	1100	1450	1650

3 entrances

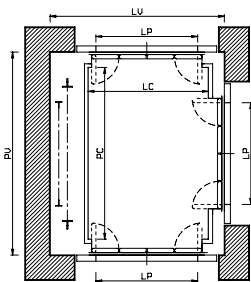

	load (kg)		
	150	360	385
LC	620	1200	1100
PC	870	1200	1400
LP	500	800	900
LV	1080	1640	1560
PV	1200	1540	1740

all dimension in mm

- LC cabin width
- PC cabin depth
- LP door opening
- LV shaft width
- PV shaft depth

SHE Automatic doors 2 panels

1 entrance rear frame

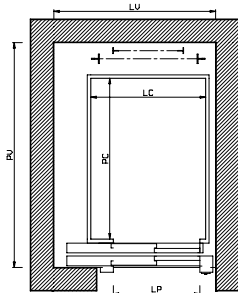

	load (kg)		
	200	270	385
LC	1050	900	1200
PC	540	1200	1200
LP	700	750	800
LV	1250	1300	1400
PV	1100	1760	1760

1 entrance side frame

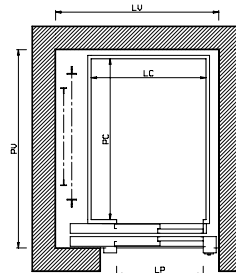

	load (kg)		
	225	270	385
LC	870	900	1100
PC	920	1200	1400
LP	700	750	900
LV	1250	1300	1550
PV	1250	1550	1750

2 opposite entrances

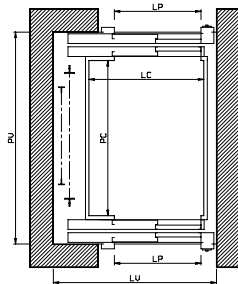

	load (kg)		
	225	270	385
LC	870	900	1100
PC	930	1200	1400
LP	700	750	900
LV	1250	1300	1550
PV	1450	1720	1920

2 adjacent entrances

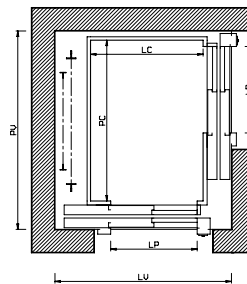

	load (kg)		
	300	360	385
LC	870	1200	1100
PC	1000	1200	1400
LP	700	800	900
LV	1430	1760	1750
PV	1350	1550	1750

3 entrances

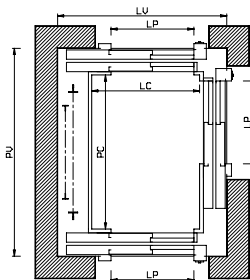

	load (kg)		
	300	360	385
LC	870	1200	1100
PC	1020	1200	1400
LP	700	800	900
LV	1430	1760	1750
PV	1540	1720	1920

all dimension in mm

LC cabin width
 PC cabin depth
 LP door opening
 LV shaft width
 PV shaft depth

SHE Automatic doors 3 panels

1 entrance rear frame

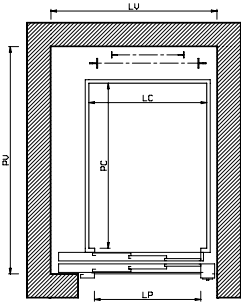

	load (kg)		
	200	270	330
LC	840	900	1100
PC	540	1200	1200
LP	600	750	800
LV	1000	1200	1280
PV	1040	1700	1700

1 entrance side frame

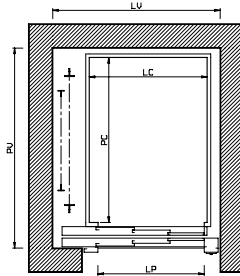

	load (kg)		
	225	270	385
LC	650	800	1100
PC	930	1200	1400
LP	600	750	900
LV	1030	1200	1480
PV	1200	1480	1680

2 opposite entrances

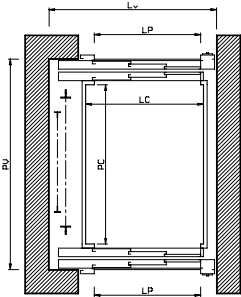

	load (kg)		
	225	270	385
LC	650	800	1100
PC	950	1200	1400
LP	600	750	900
LV	1030	1200	1450
PV	1350	1600	1800

2 adjacent entrances

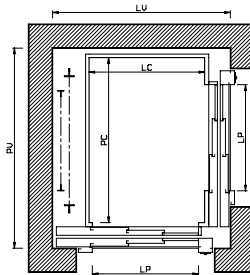

	load (kg)		
	200	360	385
LC	660	1200	1100
PC	930	1200	1400
LP	600	800	900
LV	1160	1700	1600
PV	1200	1480	1680

3 entrances

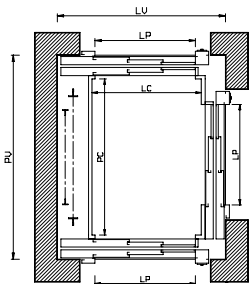

	load (kg)		
	200	360	385
LC	660	1200	1100
PC	1070	1200	1400
LP	600	800	900
LV	1160	1700	1600
PV	1470	1600	1800

all dimension in mm

- LC cabin width
- PC cabin depth
- LP door opening
- LV shaft width
- PV shaft depth



All the informations, technical data, design, colors and any other on this document, including physical samples are given to the customer as example only and then it cannot be considered binding.

Any sample or printed color cannot be considered definitive and the final result may change due to different material, color or finish.

SELE S.R.L. reserves the right to change the technical and aesthetical features without notice.



SELE srl
Via 25 Aprile 1945, n°63
40055 Castenaso (BO)
T. +39.051.60.59.801
info@selelift.com
www.selelift.com



UNI EN ISO 9001:00
ALL XIII.95/16/CE NR. I 0305

OHSAS 18001
OCCUPATIONAL HEALTH AND SAFETY
ASSESSMENT SPECIFICATION



Safe lift, simple life.



LIFTS



HOME LIFTS



GOODS
LIFTS



MODERNISATIONS



ESCALATORS

selelift.com